

InBody370s

User's Manual

Please note the important information below before reading this manual.
This product can also be used for medical purposes as the InBody370S measures body composition.

 **Warning**

Failure to comply with safety warnings and regulations can cause serious injury or death.

 **Caution**

Failure to comply with safety cautions and regulations can cause injury or property damage.

InBody

InBody Co., Ltd. [HEAD OFFICE]

625, InBody Bldg., Eonju-ro, Gangnam-gu, Seoul 06106 Republic of Korea

TEL: +82-2-501-3939

FAX: +82-2-578-5669

Website: inbody.com

E-mail: info@inbody.com

©2020 InBody Co., Ltd. All rights reserved.

Reproduction, adaptation, or translation of this manual is prohibited without prior written consent from InBody Co., Ltd. under the copyright laws. This manual might have typographical errors, and its content can be changed without a prior notice. InBody Co., Ltd. shall not be liable for any errors, incidental, or consequential damages that occurred by not complying with the content of the User's Manual.

Visit our website inbody.com to view and download further information about the functions of the InBody370S, the explanation of results output, and more. InBody Co., Ltd. reserves the right to modify the appearance, specifications, and etc. of the InBody370S to improve the quality of the product, without prior notice for reasons of performance improvement.

Representative & Sponsor Information

InBody Europe B.V.

Gyroscoopweg 122, 1042 AZ, Amsterdam, The Netherlands

TEL: +31-20-238-6080 FAX: +31-6-5734-1858 Website: nl.inbody.com E-mail: info.eu@inbody.com

Australian Sponsor. [AUSTRALIA]

Emergo AUSTRALIA. Level 20, Tower II, Darling Park, 201 Sussex Street, Sydney, NSW 2000, AUSTRALIA

TEL: +61-2-9006-1662 FAX: +61-2-9006-1010 Website: emergogroup.com E-mail: Sponsor@emergogroup.com

Customer Service Information

InBody USA [USA]

13850 Cerritos Corporate Dr. Unit C Cerritos, CA 90703 USA

TEL: +1-323-932-6503 FAX: +1-323-952-5009 Website: inbody.com E-mail: info.us@inbody.com

InBody Japan [JAPAN]

Tani Bldg., 1-28-6, Kameido, Koto-ku, Tokyo 136-0071 Japan

TEL: +81-3-5875-5780 FAX: +81-3-5875-5781 Website: inbody.co.jp E-mail: inbody@inbody.co.jp

InBody China [CHINA]

903, 904, XingDiPlaza, No.1698 YiShanRoad, Shanghai 201103 China

TEL: +86-21-64439705 FAX: +86-21-64439706 Website: inbodychina.com E-mail: info@inbodychina.com

InBody370s

User's Manual Contents

I. InBody370S Installation

A. Product Components	4
B. Operating Environment	5
C. Installation Instructions	5
D. Initial Setup	8
E. Connecting Printer, Thermal Printer, Stadiometer, Blood Pressure Monitor and Barcode Reader	12
F. Maintenance	15

II. InBody Test

A. Precautionary Steps	16
B. Test Instructions	17
C. Test Posture	18

III. Transportation and Storage

A. Cautions during Transportation	19
B. Repacking Instructions	19
C. Transportation and Storage Environment	19

IV. Frequently Asked Questions (FAQ)

A. Regarding the InBody	20
B. Regarding the InBody Test	22

V. Others

A. Exterior and Functions	23
B. Safety Information	26
C. Classification	28
D. Specifications	28
E. EMC declaration	31

I. InBody370S Installation

A. Product Components

The InBody370S consists of the following components. Please make sure all of the following components are present.

* Please inspect each component of the InBody370S for defects prior to installation.

- 1 InBody370S
- 2 Adapter (DC 12V, 3.4A/3.34A) 1 EA
- 3 Power cord 1 EA
- 4 User's Manual 1 EA

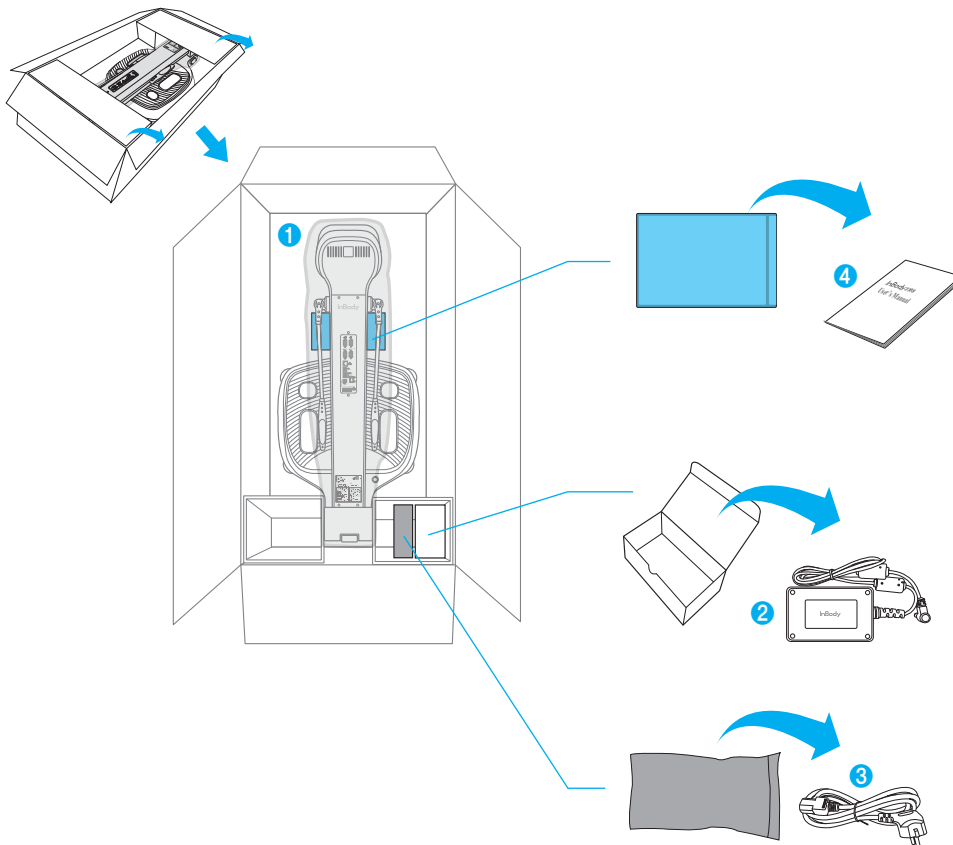
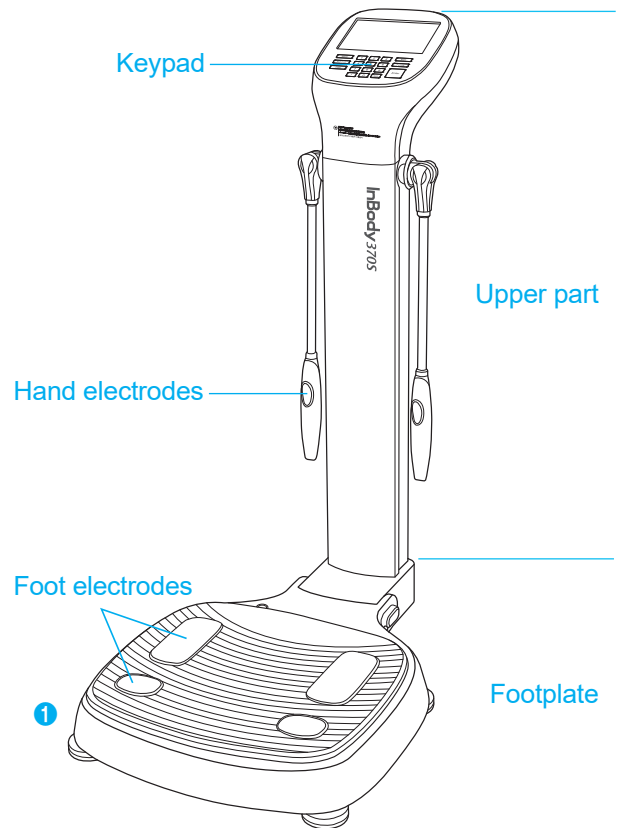

B. Operating Environment

Please make sure that the environment is adequate for the InBody370S installation. This equipment is designed for indoor use. If installing outdoors, the following requirements must be fulfilled.

Temperature range	10 ~ 40°C (50 ~ 104°F)
Relative humidity	30 ~ 75% RH
Atmospheric pressure	70 ~ 106kPa

C. Installation Instructions

1. Open the packing box of the InBody370S and remove the packing pads. Then take the InBody370S out of the box.

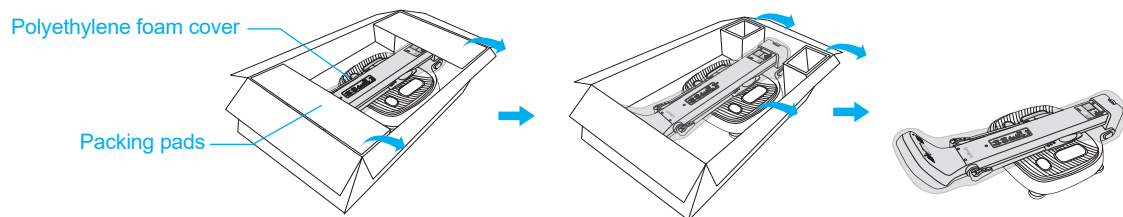

! Caution

- If you have any problems installing your InBody370S, please contact InBody for assistance.
- Do not transport the equipment by holding the screen portion or the joints of the hand electrodes.
- Keep the packing materials provided for repacking the equipment in the future. Other wastes should be disposed of according to relevant laws and regulations.

2. After completely raising the upper part of the InBody370S, remove the polyethylene foam cover.

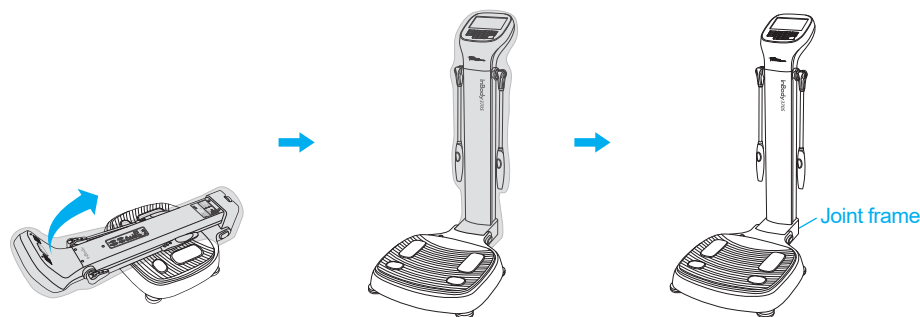

* Please refer to the following illustrations to properly transport the equipment.

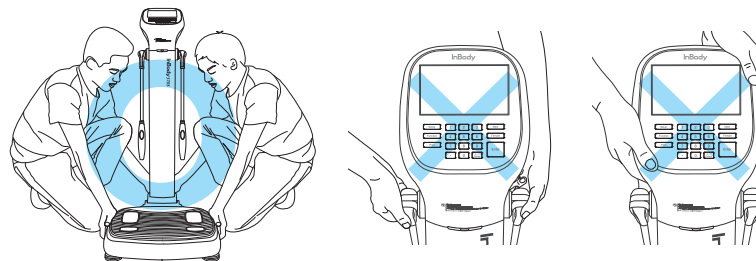

! Caution

- Using the InBody370S on carpet may cause static electricity, which could damage the equipment. If installing the InBody370S on carpet is unavoidable, please use an antistatic mat.
- Install the InBody370S on a leveled, non-vibrating surface. Installing the equipment on an uneven surface may cause the examinee to fall down. Test results may also be inaccurate.
- Never clean the hand and foot electrodes with liquid spray or detergent directly. The equipment may corrode and/or malfunction if the liquid or detergent leaks inside. Use the InBody Tissue when cleaning the InBody370S.

3. Level the InBody370S by rotating the leveling screws under the footplate to the left and right so that the air bubble is centered.

* Leveling the equipment is necessary for accurate measurement of weight. There are a total of 5 leveling screws.

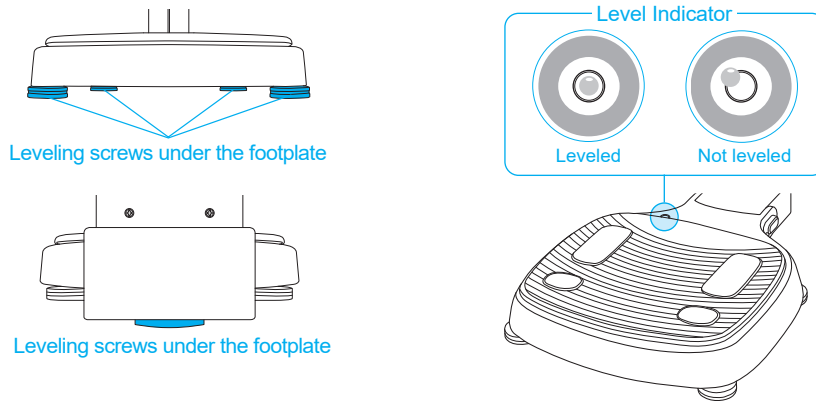

⚠ Caution

- Avoid injuring your hands when rotating the leveling screws under the footplate.

4. Connect the adapter (2) to the power input port, which is located on the rear panel (1). Connect the adapter (2) to the power cord (3). Plug the power cord (3) into a grounded 3-socket outlet.

* The InBody370S can be used in connection with other equipment such as a stadiometer, a blood pressure monitor, data management software called Lookin'Body, or a barcode reader. For more information, please refer to 'A. Exterior and Functions 3. Rear Panel' in section 'V. Others' in this User's Manual.

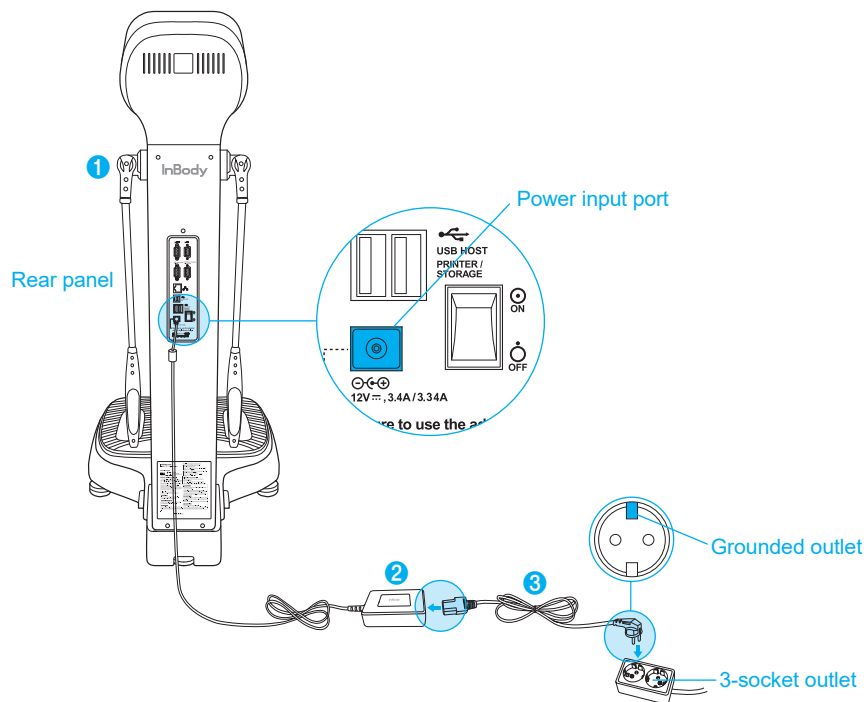

⚠ Warning

- Do not place the InBody370S in a location making it difficult to disconnect the power cord.
- Do not plug in or pull out the power cord with wet hands. There is a risk of an electric shock.
- Always use an outlet connected to the power (AC 100 - 240 V). Using other power rated outlets may result in fire or malfunction.
- When using a power surge protector, make sure that the outlet or the extension cable has adequate power capacity.
- Do not disassemble or modify the equipment including internal parts without written consent from the manufacturer. This may cause electric shock or injury, product malfunction, inaccurate results, and will void the manufacturer's warranty.

- If this equipment is modified, appropriate inspection and testing must be conducted to ensure continued safe use of equipment.
- Do not directly contact the InBody370S with any other electronic device when the InBody370S is on. This may result in an electric shock.

 **Caution**

- If the InBody370S is not plugged into a grounded outlet, it may cause damage through electric surges or product malfunction. This may affect the test results.
- The test results may be inaccurate if the InBody370S is under electrical interference. Do not install the InBody370S near products that generate electrical interference such as fluorescent lights, large AC motor equipment (treadmill, vibration plate, refrigerator, air-conditioner, compressor, etc.), high-frequency thermal therapy equipments, or heating appliances. Do not share the power source of the InBody370S with other electrical devices. This may affect the test results.
- When connecting the InBody370S with other test equipment, turn on the other equipment first. When turning off other equipment, turn off the InBody370S first. This is necessary to minimize electrical surges on the InBody370S.
- Always use the specified adapter provided by InBody as it is a part of the InBody370S. Using other adapters may result in malfunction of the InBody370S.
- Operation of the InBody370S 2,000m above sea level may affect the weight measurement.
- Adapter must be arranged so that easily cut off the power when a problem occurs in the InBody370S.

5. Flip the power switch to turn on the InBody370S.

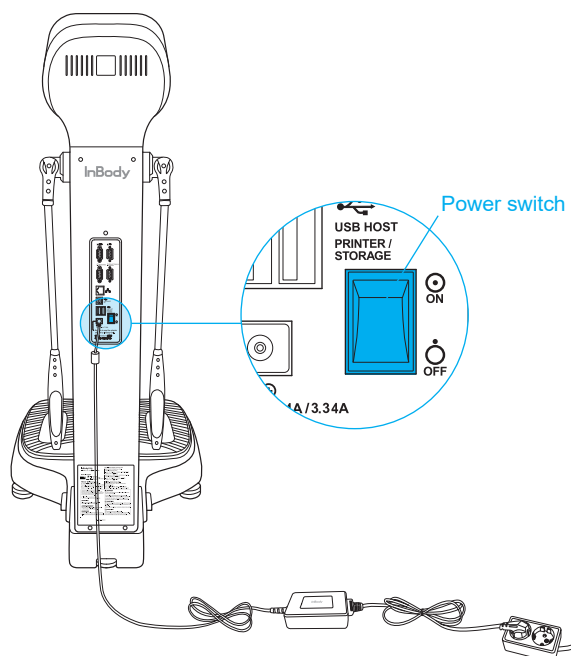

D. Initial Setup

- The InBody370S automatically starts booting when it is turned on. While booting, it performs a self weight calibration.
 - * While booting (about 5 minutes), make sure there is nothing on top of the footplate. Please do not stand on the footplate, or place objects on the footplate.

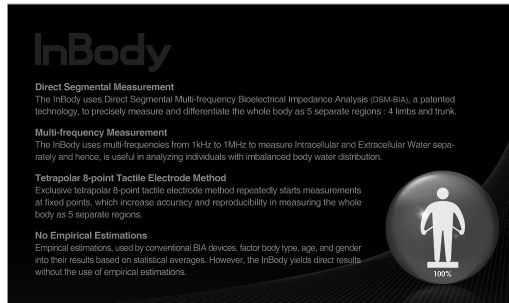

- Press the [Administrator Menu] button on the screen, which appears when no one is on the footplate.

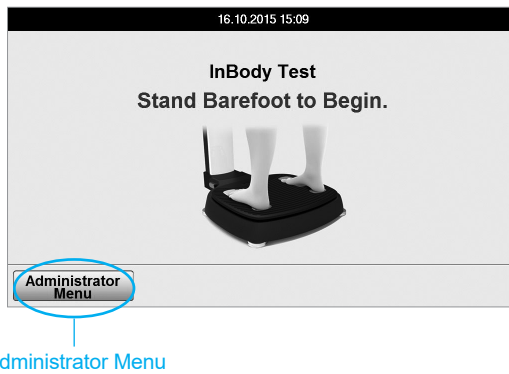

- Input the password (default password: 0000) to access the Administrator Menu.

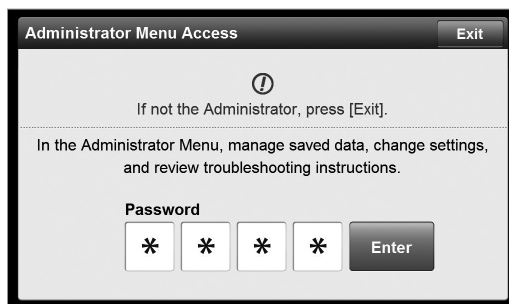

- The Administrator Menu will give you access to 'Setup' and 'Troubleshooting'.

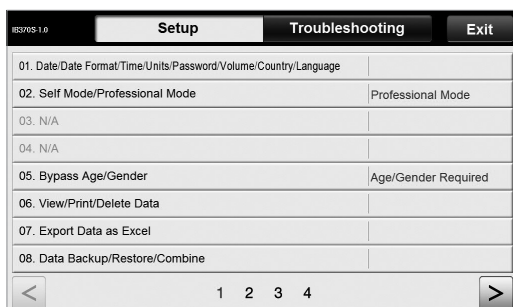

Setup

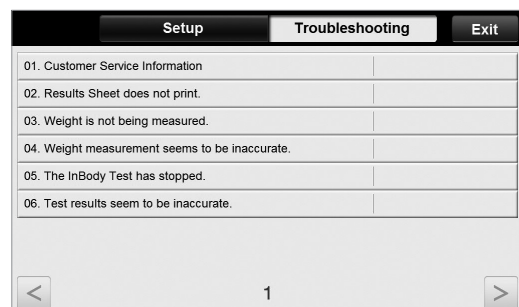

Troubleshooting

- 1) Setup: Configure settings and manage data according to the test environment.
 01. Date/Time/Units/Country/Language/Password/Volume
: Change or modify the InBody's basic settings.
 02. Self Mode/Professional Mode
 - Self Mode: The examinee takes the InBody Test by entering only his/her height.
Throughout the test, instructions and the InBody Information will be shown on screen.
 - Professional Mode: An examiner is present and guiding the examinee through the InBody Test.
 03. N/A
 04. N/A
 05. Bypass Age/Gender
: The examinees can bypass inputting their age or gender if the test environment is designed for testing only adults or a specific gender.
 06. View/Print/Delete Data
: The administrator can manage test results using ID.
 07. Export Data as Excel
: You can export test results as an excel file on a USB Thumb Drive. Exported test results can be viewed as an excel file on a computer.
 08. Data Backup/Restoration/Combine
: Back up InBody Test results to a USB Thumb Drive, or restore test results using a backup file on a USB Thumb Drive, or add test results using a backup file on a USB Thumb Drive to the InBody.
 09. Printer Setup
: Connect the printer to the InBody. A connected printer will allow for printing results sheets after testing.
 10. Results Sheet Types
: Select which results sheets to utilize with the InBody370S.
(InBody Results Sheet, InBody Results Sheet for Children, and Thermal Results Sheet).
 11. Automatic Printing Options
: Print applicable results sheets automatically after each completed test. The InBody can print up to 2 copies after every test.
 12. Paper Types
: Select the paper type for printed results sheets. Options include blank A4 paper or pre-printed InBody Results Sheets provided by InBody.
 13. Outputs/Interpretations for Results Sheet
: This option allows you to configure the outputs and interpretations appearing on the right-hand side of the InBody Results Sheet, the InBody Results Sheet for Children, and the Thermal Results Sheet.

14. Results Sheet Custom Logo
 - : Insert a logo on upper right corner of the printed results sheet.
 - * Please contact InBody for help with uploading or modifying a logo.
15. Printing Alignment
 - : Adjust the alignment of where the results will be printed on the results sheets.
16. Internet Options
 - : You can connect the InBody to the Internet. When the InBody is connected to the internet, can connect to data management software Lookin'Body, regardless of location.
17. Bluetooth
 - : Connect the InBody to data management software Lookin'Body, via Bluetooth connection.
18. Manual/Automatic Weight
 - : Select whether to proceed testing by entering the examinee's weight manually or by taking the weight measurement automatically.
19. Adjust Weight
 - : Adjust measured weight by a fixed value on the InBody. (Example: Workout clothes at the gym are approximately 0.2kg; most examinees are assumed to be wearing workout clothes, so the examiner may adjust the set value to -0.2kg.)
20. Normal Range
 - : Set the normal range for BMI, Percent Body Fat, and Waist-Hip Ratio.
 - * The ideal value of BMI may also be set.
21. N/A
22. Standard Child Growth Curve
 - : Set the type of standard child growth curve to use on the InBody Result Sheet for Children.
23. Touchscreen Alignment
 - : Adjust the alignment of the touchscreen.
24. Customer Service Information
 - : Save the customer service (supplier) contact information. Please refer to the customer service information if you have any inquiries regarding the InBody Test, or problems that cannot be resolved through the 'Troubleshooting' menu.
25. Auto-Lock
 - : Set a password or screen lock (auto-lock) time to secure the InBody usage.

2) Troubleshooting: See additional information on how to use the InBody. Refer to troubleshooting checklist when there are problems that occur during the InBody use/test.

01. Customer Service Information

: See the customer service contact information saved under the Setup of the Administrator Menu '24. Customer Service Information'. Please contact the customer service if your problem cannot be resolved through the 'Troubleshooting' or if you need further inquiries regarding the InBody Test.

02. Results Sheet does not print.

: View the troubleshooting checklist when the Results Sheet does not print by the printer connected to the InBody.

03. Weight is not being measured.

: View the troubleshooting checklist when weight is not being measured, after stepping on to the InBody footplate.

04. Weight measurement seems to be inaccurate.

: View the troubleshooting checklist when the weight measurement seems to be inaccurate.

05. The InBody Test has stopped.

: View the troubleshooting checklist when the InBody Test has stopped.

06. Test results seem to be inaccurate.

: View the troubleshooting checklist when the test results seem to be inaccurate.

E. Connecting Printer, Thermal Printer, Stadiometer, Blood Pressure Monitor and Barcode Reader

1. Printer

In order to print InBody Results Sheets, an InBody370S compatible printer is required.

* A list of printers compatible with the InBody370S can be found at <https://www.inbodyservice.com>.

1) First turn off the InBody370S and then the printer.

* You may experience connection issues in connecting the printer to the InBody370S if the InBody is turned on.

2) Plug the USB cable provided with the printer into the USB HOST port on the rear panel of the InBody370S and plug the other end of the USB cable into the printer.

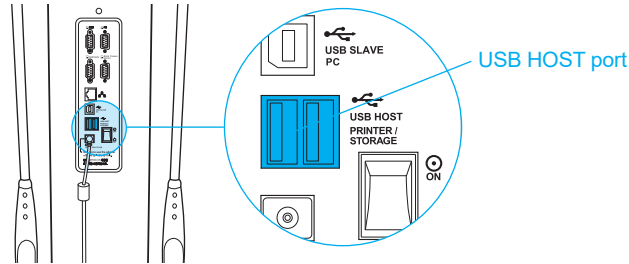

3) Turn on the printer.

4) Turn on the InBody370S and setup your printer under Settings of the Administrator Menu '09. Printer Setup'.

5) You can edit your printing settings under Settings of the Administrator Menu from '10. Results Sheet Types' through '15. Printing Alignment'.

2. Thermal Printer

Connect thermal printer to the InBody370S to print Thermal Results Sheet.

* Always connect a thermal printer from InBody.

1) Turn off the InBody370S.

* For best result, the InBody370S should be turned off when connecting to thermal printer.

2) Plug the serial cable provided with the COM to the 9-pin COM serial port on the rear panel of the InBody370S. Then, connect the other end of the serial cable to the serial port on to thermal printer.

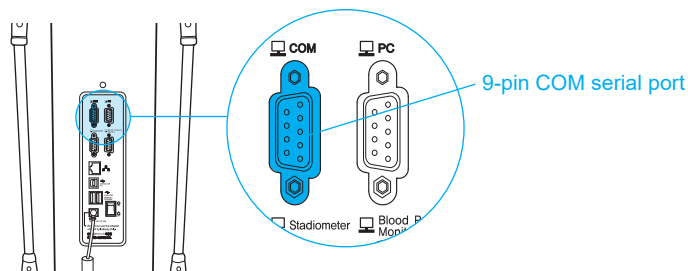

3) Turns on the thermal printer.

4) Turn on the InBody370S.

5) Go to Setup in Administrator Menu and select 'Thermal Results Sheet' under '10. Results Sheet Types' and configure the items printed to the Thermal Results Sheet under '13. Outputs/Interpretations for Results Sheet'.

3. Stadiometer

If a stadiometer is connected to the InBody370S, the height values measured by the stadiometer will be sent directly to the InBody370S.

* Always connect a stadiometer from InBody.

1) First turn off the InBody370S and then the stadiometer.

* You may experience connection issues in connecting the stadiometer to the InBody370S if the InBody is turned on.

2) Plug the serial cable provided with the stadiometer to the 9-pin stadiometer serial port on the rear panel of the InBody370S.

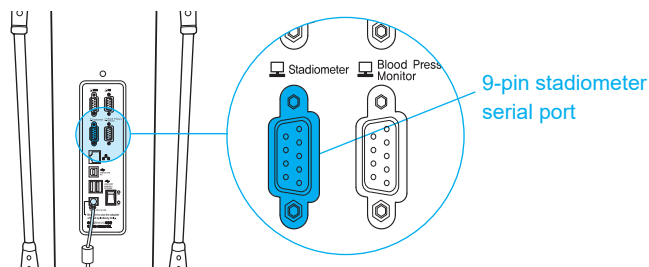

3) Turn on the stadiometer.

4) Turn on the InBody370S. If the stadiometer is connected to the InBody370S, the stadiometer icon () will appear on the top left corner of the screen when no one is on the footplate.

4. Blood Pressure Monitor

If a blood pressure monitor is connected to the InBody370S, the blood pressure values measured by the blood pressure monitor will be sent directly to the InBody370S.

* Always connect a blood pressure monitor from InBody.

* If you select to print blood pressure measurements under Settings of the Administrator Menu '13. Outputs/Interpretations for Results Sheet', the blood pressure measurements will be printed on the InBody Results Sheet.

1) First turn off the InBody370S and then the blood pressure monitor.

* You may experience connection issues in connecting the blood pressure monitor to the InBody370S if the InBody is turned on.

2) Plug the serial cable provided with the blood pressure monitor to the 9-pin blood pressure monitor serial port on the rear panel of the InBody370S.

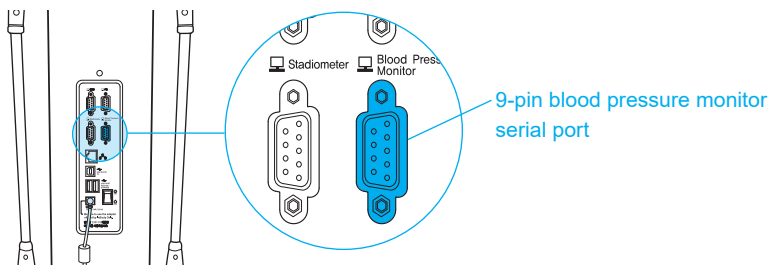

3) Turn on the blood pressure monitor.

4) Turn on the InBody370S. If the blood pressure monitor is connected to the InBody370S, the blood pressure monitor icon () will appear on the top left corner of the screen when no one is on the footplate.

5. Barcode Reader

If a barcode reader is connected to the InBody370S, the ID will be inputted automatically.

* If the InBody cannot recognize the barcode reader, please contact InBody.

1) First turn off the InBody370S.

* You may experience connection issues in connecting the barcode reader to the InBody370S if the InBody is turned on.

2) Plug the USB cable of the barcode reader into the USB HOST port on the rear panel of the InBody370S.

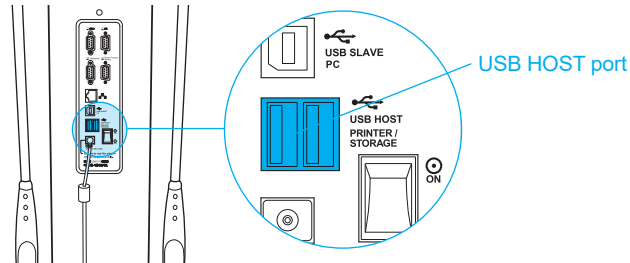

3) Turn on the InBody370S. If the barcode reader is connected to the InBody370S, the barcode reader icon() will appear on the top left corner of the screen when no one is on the footplate.

F. Maintenance

Caution

- Do not bend the handles of the hand electrodes or rotate them in the reverse direction beyond its limitation.
- Do not extend the handles of the hand electrodes beyond its limitation.
- Do not place any objects on the footplate.
- Do not apply excessive force on the equipment.
- Turn off the equipment if you are not using it for a day or longer.
- Do not allow any liquid substances to contact the equipment directly. Keep food and drinks away from the equipment. Substances getting inside the equipment can cause critical damage to the electronic components.
- Use a lint-free cloth to gently wipe the external surface of the equipment about once every week. Be careful not to scratch the LCD screen.
- InBody370S does not need regular maintenance. If some problems occur while operating the device, get in touch with the store where you purchased it or A/S manager.

We do not take the responsibility about problems caused by any arbitrary repairs.

II. InBody Test

A. Precautionary Steps

Warning

- Individuals with medical implant devices such as pacemakers, or essential support devices such as patient monitoring systems, must not use this equipment. Safe, low-level currents will flow through the body during the test, which may cause malfunctioning of the device or endanger lives.
- Children and people with limited mobility should be supervised or assisted when attempting to test on the InBody.
- After an individual with any kind of contagious disease or infection tests on the InBody, use an InBody Tissue to clean the equipment.

Caution

- Stand upright for about 5 minutes before testing. Taking the test immediately after lying in bed or sitting for a long period of time might result in a slight change in the test results. This is because body water tends to move to the lower body as soon as the person stands or gets up.
- Do not eat before testing. In cases where the examinee has already eaten, the test should be put off for at least two hours after the meal. This is because food mass is included in the examinee's weight and thus, may result in measurement errors.
- Use the bathroom before testing. Waste is not included in the body's compositional elements, but the volume of urine and excrement is included in the weight measurement affecting accuracy of the test results.
- Do not exercise before testing. Strenuous exercise or sharp movements can cause temporary changes in body composition. Even light exercise can change your body composition temporarily.
- Take the test in the morning, if possible. Body water tends to gravitate towards the lower body throughout the day, affecting accuracy of the test results.
- Thoroughly wipe the palms and soles with the InBody Tissue before testing. Testing may be difficult if the examinee's palms and soles are too dry or if the examinee has too many calluses.
- Avoid contact with the examinee during testing. Contact may lead to interference affecting test results.

B. Test Instructions

1. Step on the footplate when the screen below is shown.

- * The screens vary according to the Settings of the Administrator Menu '02. Self Mode/Professional Mode'.
- Professional Mode: An examiner is present and guiding the examinee through the InBody Test.
- Self Mode: The examinee takes the InBody Test following the instructions that are displayed on screen.



2. Weight measurement begins.

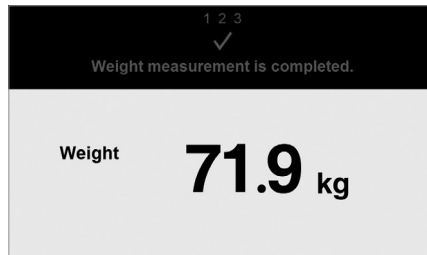

3. Input personal information.

- * Input height only if using Self Mode.
- * In Professional Mode, enter the ID.

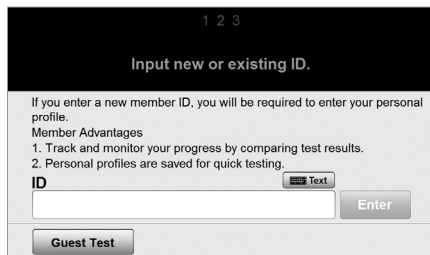

Professional Mode

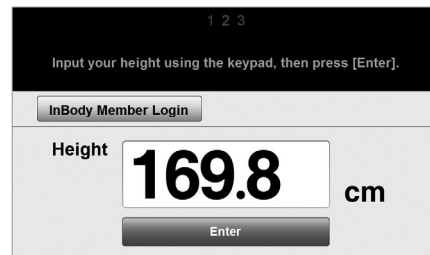

Self Mode

4. Maintain proper posture to take the test.

- * Refer to 'C. Test Posture' for the proper posture.



5. The InBody Test begins.

- * InBody Information is shown if using Self Mode.

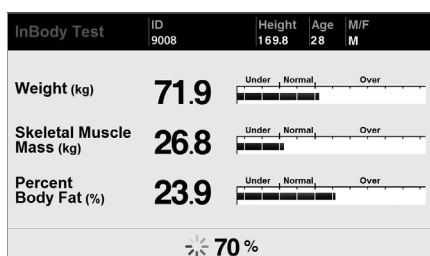

Professional Mode

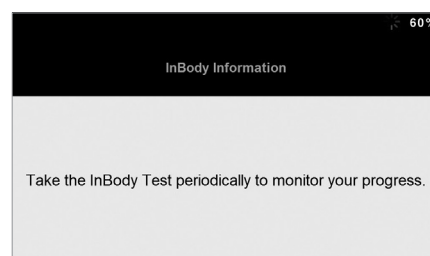

Self Mode

6. When the test is completed, the results will be shown on screen.

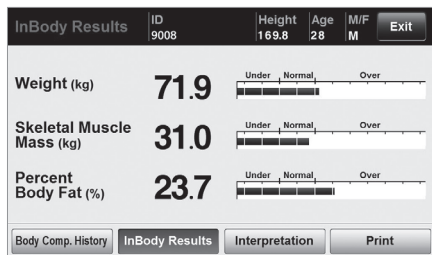

Professional Mode

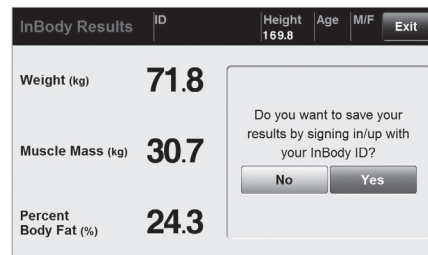

Self Mode

C. Test Posture

The examinee must maintain proper posture to have accurate test results.

* The test will proceed when there is good electrical contact.

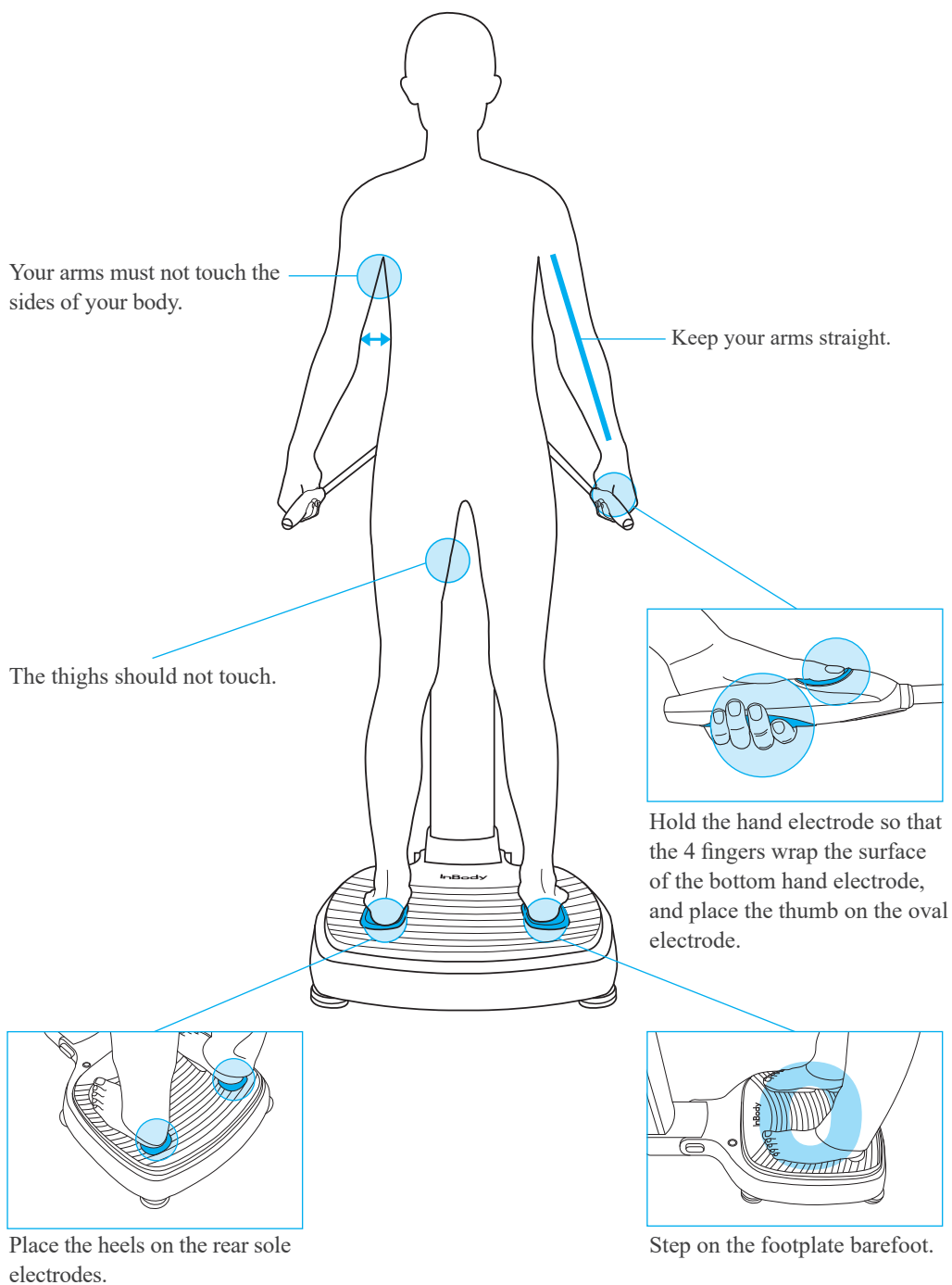

III. Transportation and Storage

A. Cautions during Transportation

When transporting, have two people keep the InBody370S parallel to the ground.

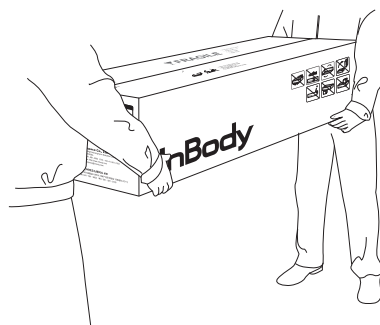

B. Repacking Instructions

Once the InBody370S is installed, avoid transporting the equipment. If it must be transported, repack it in the following sequence.

1. Turn off the InBody370S.
2. Separate the connected adapter, cords, and cables from the equipment, and cover the InBody370S with the polyethylene foam cover. After covering the InBody, lower the upper part.



3. Put the InBody into the packing box. Place the packing pad over the equipment and tape up the packing box.

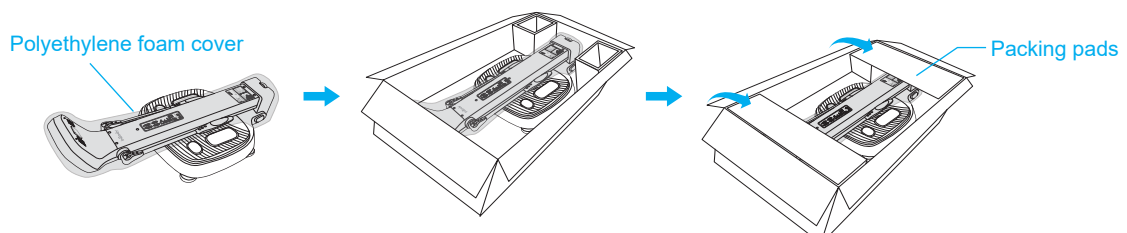

⚠ Caution

- Always use the protective packing materials provided by InBody when repacking.

C. Transportation and Storage Environment

The InBody370S should be transported or stored under the following conditions.

Temperature range	-10 ~ 70°C (14 ~ 158°F)
Relative humidity	10 ~ 80% RH (No Condensation)
Atmospheric pressure	50 ~ 106kPa

IV. Frequently Asked Questions (FAQ)

Even if no problems arise from the equipment, users may still have many questions, especially regarding clinical procedures. Few common questions and answers are listed below. If your questions are not answered here, please contact InBody.

* Customer contact information can be found under Settings of the Administrator Menu '24. Customer Service Information'.

A. Regarding the InBody

If a problem arises with the InBody370S, you may first attempt to check the 'Troubleshooting' in the Administrator Menu. The InBody370S can help you diagnose and solve some problems. If your problem cannot be resolved through the 'Troubleshooting', please refer to the possible solutions below.

Question	Answer
----------	--------

- My InBody370S does not turn on.

- Insert the power plug completely into a grounded 3-socket outlet.

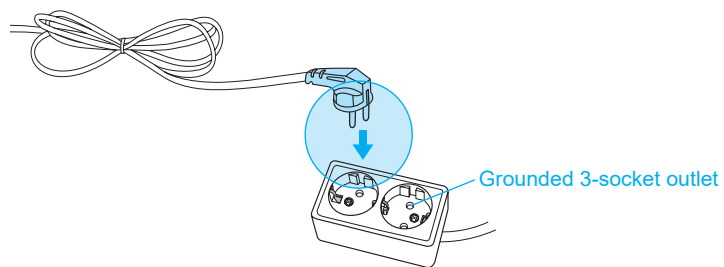

- When using a power surge protector, the equipment may not power on if the power switch on the power surge protector is turned off. Check the power surge protector which the power plug is connected to.

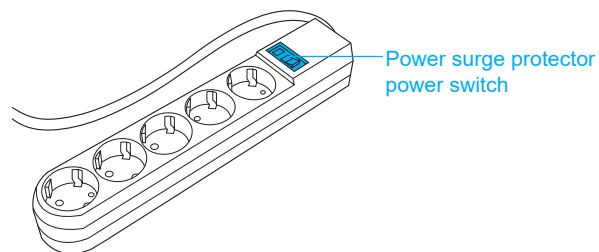

- The problem may occur if the power cord is not completely plugged into the adapter. Insert the power cord completely into the adapter.

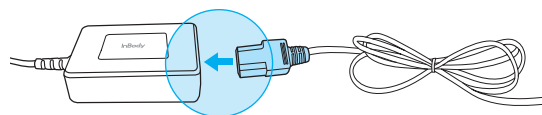

- The problem may occur if you are using the power adapter that is not provide by InBody. Always connect a power adapter (DC 12V, 3.4A/3.34A) provided by InBody.

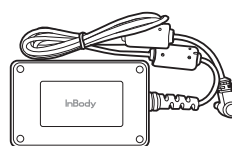

Power adapter

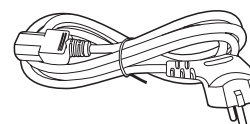

Power cord

Question	Answer
<ul style="list-style-type: none"> • My touchscreen is inaccurate or not responsive. 	<ul style="list-style-type: none"> • Calibrate the touchscreen under Settings of the Administrator Menu '23. Touchscreen Alignment'. <ul style="list-style-type: none"> * Press firmly to optimize touchscreen response. • If you cannot enter the Administrator Menu due to touchscreen problems, please restart the InBody. The InBody stores the last touchscreen alignment and will automatically recall the previous touchscreen settings. The InBody can also recognize if its touchscreen alignment is off screen and will automatically take the user to the calibration screen after restarting.
<ul style="list-style-type: none"> • I would like to connect other equipment to the InBody370S. 	<ul style="list-style-type: none"> • Please refer to 'E. Connecting Printer, Thermal Printer, Stadiometer, Blood Pressure Monitor and Barcode Reader' in section 'I. InBody370S Installation' in this User's Manual.

B. Regarding the InBody Test

Some of the more common clinical questions are answered below. If additional questions or more clarification is desired, please contact InBody.

Question	Answer
<ul style="list-style-type: none"> • Must socks or stockings be removed for the InBody Test? 	<ul style="list-style-type: none"> • Bare skin contact is essential in the analysis using the BIA method. Socks or stockings may cause a varying degree of distortion in the results. Socks or stockings must be removed to obtain accurate data.
<ul style="list-style-type: none"> • Is it okay to wear accessories (jewelry, watch, rings, etc) or metal objects while taking the InBody Test? 	<ul style="list-style-type: none"> • The ideal condition for the analysis is simply standing with no clothes and wearing no accessories. However, this may not always be possible. Therefore, we recommend that the examinee remove as many clothing items and accessories that may affect the weight as possible.
<ul style="list-style-type: none"> • Who cannot take the InBody Test or will have difficulties taking the InBody Test? 	<ul style="list-style-type: none"> • Individuals with medical implant devices such as pacemakers, or essential support devices such as patient monitoring systems, must not use this equipment. The currents will flow through the body during the test, which may cause malfunctioning of the device or endanger lives. • Children, amputees, or the elderly, may have trouble testing if they cannot hold the hand electrodes or stand still on the foot electrodes.
<ul style="list-style-type: none"> • Can a person with metal implants in the body take the InBody Test? 	<ul style="list-style-type: none"> • The ideal test methodology is where the examinee does not wear anything metallic. Individuals with metallic implants may have skewed test results due to the conductivity of the metal affecting the results. • As the weight of clothes and other wear affects the results of the body composition analysis, it is strongly recommended to take off any heavy clothing or metallic wear. Except for the weight, jewelry does not effect the body composition analysis, as the contact point with the InBody370S are hands and feet.
<ul style="list-style-type: none"> • I have limited mobility and cannot maintain proper posture for the InBody Test. How can I still be tested? 	<ul style="list-style-type: none"> • It is impossible to test if an individual cannot maintain contact with the hand or foot electrodes. InBody has a line of products that conduct body composition analysis on bed ridden examinees that allow the patients to stay in bed. For more information, please contact InBody.
<ul style="list-style-type: none"> • Is the electric current harmful to the body? 	<ul style="list-style-type: none"> • The physiological electric impedance method uses safe low level currents that is not harmful to the body. The safety of the InBody has been tested and proven. The InBody products have been approved for medical use by the CE and all over the world. Many medical institutions around the world are actively using the InBody.
<ul style="list-style-type: none"> • How often should I take the InBody Test? 	<ul style="list-style-type: none"> • Individuals who are undergoing any programs that may affect their body composition are strongly recommended to have the InBody Test done every two to four weeks. • Consistent testing will allow individuals to track and monitor their progress over time.
<ul style="list-style-type: none"> • What are the precautionary steps to ensure accuracy of the InBody Test? 	<ul style="list-style-type: none"> • Please refer to ‘A. Precautionary Steps’ in section ‘II. InBody Test’ in this User’s Manual.

V. Others

* The InBody370S is manufactured according to the quality management procedure of InBody. InBody complies with the ISO9001 and ISO13485 which are international quality management systems.

* This equipment satisfies the IEC60601-1 (EN60601-1), an international safety standard for electronic medical equipment. This equipment also satisfies the IEC60601-1-2 (EN60601-1-2), an international standard for electromagnetic conformity.

A. Exterior and Functions

The following are the names and functions of each part of the InBody.

* Please inspect each component of the InBody370S for damage prior to installation.

1. Upper Part

- ① Hand electrode: Examinee holds the hand electrode so that the 4 fingers wrap the surface of the bottom hand electrode while the thumb is placed on the oval electrode.
- ② Hand electrode joint and handle: Supports the hand electrode and encloses the wiring for the electrode.
- ③ Body: Connects the upper part of the equipment to the lower part.
- ④ LCD screen: Shows each stage of the test, instructions, test results, etc. You can touch the screen to input the data required for the test, configure settings, or view test results.
- ⑤ Number keypad: Used for inputting age, height, and other number-based data.
- ⑦ Setup button : Used for entering ‘Settings’ under the Administrator Menu when no one is on the footplate.
- ⑦ Function button: Used for entering ‘Troubleshooting’ under the Administrator Menu when no one is on the footplate.
- ⑧ Print button: Used for printing the test results.
- ⑨ Decimal point button: Used for inputting the decimal point in ID, height, age, or weight.
- ⑩ Gender buttons: Used for selecting gender (Male or Female).
- ⑪ Enter button: Used to finish inputting data or to save changes in Administrator Menu.
- ⑫ Delete button: Used for deleting inputted data.

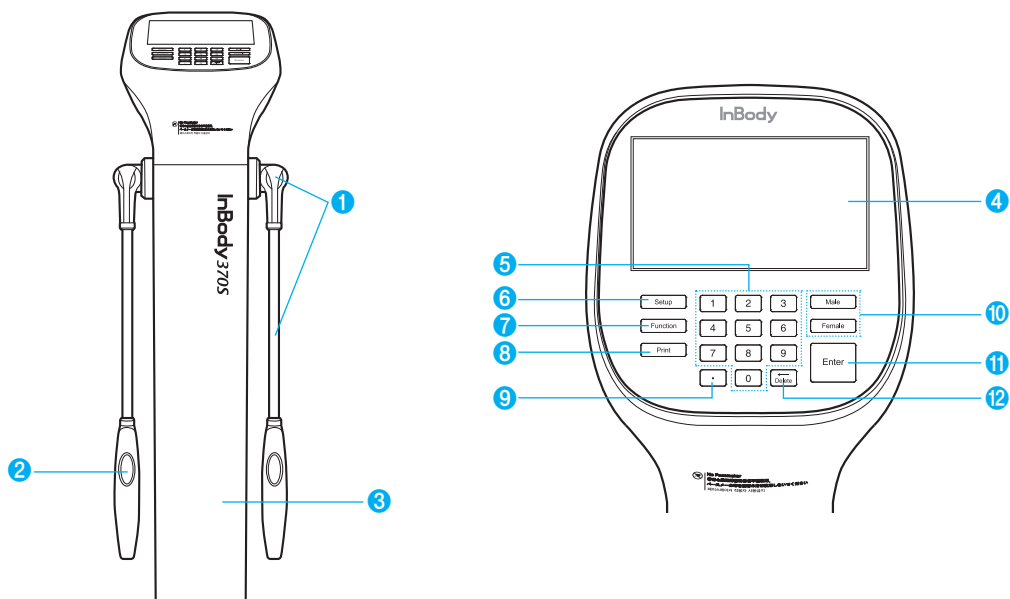

2. Footplate

- ① Front sole electrode: The examinee makes contact with this electrode by stepping with the front part of their foot.
- ② Rear sole electrode: The examinee makes contact with this electrode by stepping with the heel of their foot.
- ③ Footplate: This is connected to the scale, which measures the examinee's weight.
- ④ Level Indicator: Indicates the current horizontal level of the InBody370S.
- ⑤ Joint: Joins the upper part and lower part of the equipment together.
- ⑥ Leveling screws: Used for adjusting the horizontal level of the equipment.

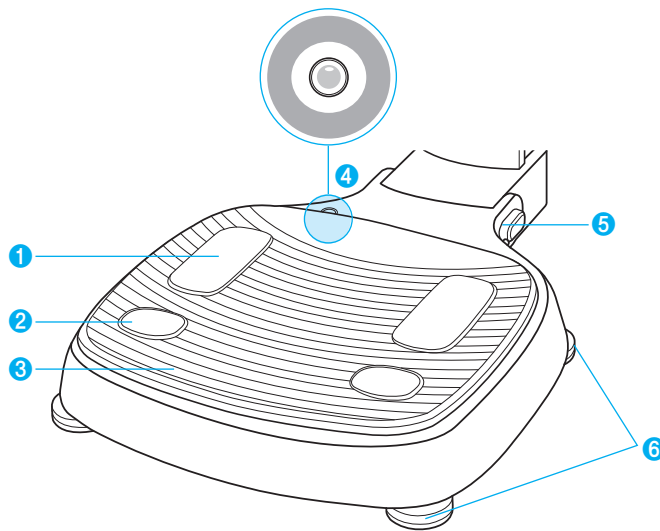

3. Rear Panel

- 1 **Speaker:** Provides audible indication for test in progress, test complete, and successfully saved setting changes.
- 2 **Rear cover:** Designed to be opened only by InBody service personnel for checking internal circuits, etc.
- 3 **9-pin COM serial port (Female, RS-232C):** Used for connecting the InBody370S to a thermal printer.
* Only compatible with a InBody thermal printer.
- 4 **9-pin PC serial port (Female, RS-232C):** Used for connecting the InBody370S to Lookin'Body installed on the computer.
* The InBody370S can be connected to Lookin'Body installed on a computer using one of the ports 4, 7, or 8.
- 5 **9-pin stadiometer serial port (Female, RS-232C):** Used for connecting the InBody370S to a stadiometer.
* Only compatible with a InBody stadiometer.
- 6 **9-pin blood pressure monitor serial port (Female, RS-232C):** Used for connecting the InBody370S to a blood pressure monitor.
* Only compatible with a InBody blood pressure monitor.
- 7 **LAN port (10T Base):** Used for connecting the InBody370S to Lookin'Body installed on a computer.
* The InBody370S can be connected to Lookin'Body installed on a computer using one of the ports 4, 7, or 8.
- 8 **USB SLAVE port:** Used for connecting the InBody370S to Lookin'Body installed on a computer.
* The InBody370S can be connected to Lookin'Body installed on a computer using one of the ports 4, 7, or 8.
- 9 **USB HOST port:** Used for connecting to a printer, a barcode reader, or a USB Thumb Drive.
- 10 **Power input port:** Used for connecting to the power adapter.
* Always use the specified adapter provided by InBody as it is a part of the InBody370S. Using other adapters may result in malfunction of the InBody370S.
- 11 **Power switch:** Used for turning on/off the equipment.

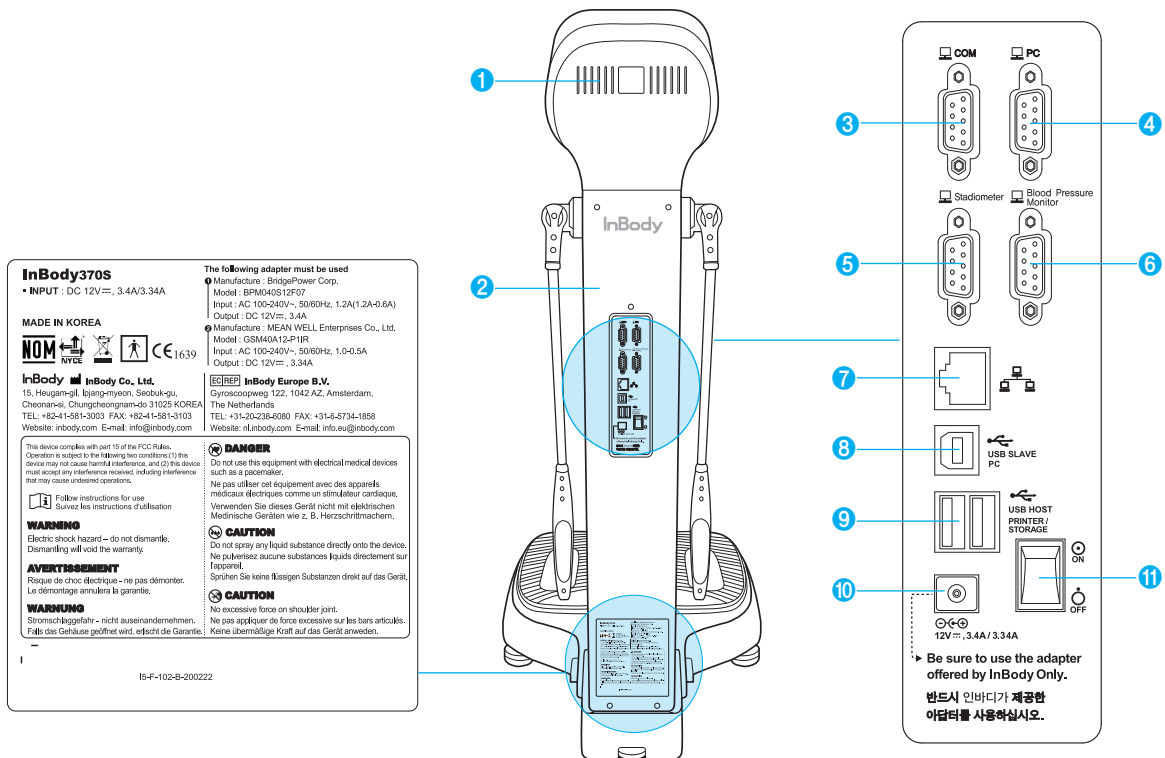



 **Warning**





- Do not touch signal input, signal output or other connectors, and the patient simultaneously.
- External equipment intended for connection to signal input, signal output or other connectors, shall comply with relevant IEC Standard(e.g., IEC60950 for IT equipment and IEC60601-1 series for medical electrical equipment). In addition, all such combination-system-shall comply with the standard IEC60601-1 and/or IEC60601-1-1 harmonized national standard or the combination. If in doubt, contact qualified technician or your local representative.

B. Safety Information





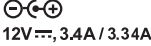

Indicators

	9-pin serial port (Female, RS-232C)
	LAN port (10T Base)
	USB port

Safety Symbols

	Dangerous High Voltage
	Warning, Caution
	BF Type Equipment
 12V $\overline{\text{---}}$, 3.4A / 3.34A	Adapter
	Power On
	Power Off

Etc. Symbols

	European Conformity		Serial number
	Manufacturer		Direct current
	Authorized representative in the EUROPEAN COMMUNITY		Operating instructions



Disposal of old Electrical & Electronic Equipment

(Application in the European Union and other European countries with separate collection system.) This symbol indicates that this product shall not be treated as household waste. Instead, it shall be handed over to the applicable collection point for the recycling of electrical and electronic equipment. By ensuring this product is disposed of correctly, you will help prevent potential negative consequences for the environment and human health, which could otherwise be caused by inappropriate waste handling of this product. For more detailed information about recycling this product, please refer to local governing ordinances and recycling plans.



Follow instructions for use

Suivez les instructions d'utilisation

WARNING

Electric shock hazard – do not dismantle.

Dismantling will void the warranty.

AVERTISSEMENT

Risque de choc électrique - ne pas démonter.

Le démontage annulera la garantie.



DANGER

Do not use this equipment with electrical medical device such as a pacemaker.

Ne pas utiliser cet équipement avec des appareils médicaux électriques comme un stimulateur cardiaque.



CAUTION

Do not spray any liquid substance directly onto the device.

Ne pulvérisez aucune substances liquids directement sur l'appareil.



CAUTION

No excessive force on shoulder joint

Ne pas appliquer de force excessive sur les bars articulés.

C. Classification

Body Composition Analyzer of Direct Segmental Multi-frequency Bioelectrical Impedance Analysis Method

- Types of protection against electric shock: Class I
- Type of the applied parts: BF Type
- Degree of protection against water infiltration: IPX0
- EMC Immunity: Level A
- EMC Emission: Level A
- Equipment is not suitable for use in the presence of flammable mixtures.

D. Specifications

Bioelectrical Impedance Analysis (BIA) Measurement Items	Bioelectrical Impedance (Z)	15 Impedance Measurements by Using 3 Different Frequencies (5kHz, 50kHz, 250kHz) at Each of 5 Segments (Right Arm, Left Arm, Trunk, Right Leg, and Left Leg)
Electrode Method	Tetrapolar 8-Point Tactile Electrodes	
Measurement Method	Direct Segmental Multi-frequency Bioelectrical Impedance Analysis Method (DSM-BIA) Simultaneous Multi-frequency Impedance Measurement (SMFIM)	
Body Composition Calculation Method	No Empirical Estimation	
Outputs (InBody Results Sheet)	<p>Results and Interpretations</p> <ul style="list-style-type: none"> • Body Composition Analysis (Total Body Water, Protein, Soft Lean Mass, Minerals, Fat Free Mass, Body Fat Mass, Weight) • Muscle-Fat Analysis (Weight, Skeletal Muscle Mass, Body Fat Mass) • Obesity Analysis (Body Mass Index, Percent Body Fat) • Segmental Lean Analysis (Based on ideal weight/Based on current weight: Right Arm, Left Arm, Trunk, Right Leg, Left Leg) • Segmental Fat Analysis (Right Arm, Left Arm, Trunk, Right Leg, Left Leg) • Body Composition History (Weight, Skeletal Muscle Mass, Percent Body Fat) • InBody Score • Body Type (Based on BMI/Percent Body Fat: Athletic Shape, Slightly Obese, Obesity, Muscular Shape, Average, Slightly Obese, Slim Muscular, Slim Sarcopenic Obesity, Thin, Slightly Thin) • Weight Control (Target Weight, Weight Control, Fat Control, Muscle Control) • Nutrition Evaluation (Protein, Minerals, Fat Mass) • Obesity Evaluation (BMI, Percent Body Fat) • Body Balance Evaluation (Upper, Lower, Upper-Lower) • Segmental Circumference (Neck, Chest, Abdomen, Hip, Right Arm, Left Arm, Right Thigh, Left Thigh) • Waist-Hip Ratio (Graph) • Visceral Fat Level (Graph) • Research Parameters (Skeletal Muscle Mass, Fat Free Mass, Basal Metabolic Rate, Waist-Hip Ratio, Waist Circumference, Visceral Fat Level, Obesity Degree, Bone Mineral Content, Recommended calorie intake per day, Calorie Expenditure of Exercise, Blood Pressure (Systolic, Diastolic, Pulse, Mean Artery Pressure, Pulse Pressure, Rate Pressure Product)) <p>Results Interpretation QR Code Impedance (Each segment and each frequency)</p>	
Outputs (InBody Result Sheet for Children)	<p>Results and Interpretations</p> <ul style="list-style-type: none"> • Body Composition Analysis (Total Body Water, Protein, Minerals, Body Fat Mass, Weight) • Muscle-Fat Analysis (Weight, Skeletal Muscle Mass, Body Fat Mass) • Obesity Analysis (Body Mass Index, Percent Body Fat) • Growth Graph (Height, Weight, BMI) • Body Composition History (Height, Weight, Skeletal Muscle Mass, Percent Body Fat) • Growth Score • Obesity Evaluation (BMI, Percent Body Fat) • Nutrition Evaluation (Protein, Minerals, Fat Mass) • Body Balance (Upper, Lower, Upper-Lower) 	

Outputs (InBody Result Sheet for Children)	<ul style="list-style-type: none"> Research Parameters (Skeletal Muscle Mass, Fat Free Mass, Basal Metabolic Rate, Child Obesity Degree, Bone Mineral Content, Growth Score, Blood Pressure (Systolic, Diastolic, Pulse, Mean Artery Pressure, Pulse Pressure, Rate Pressure Product)) Results Interpretation QR Code Impedance (Each segment and each frequency) 		
Outputs (InBody Thermal Result Sheet)	Total Body Water, Protein, Minerals, Weight, Muscle Mass, Body Fat Mass, Percent Body Fat, BMI, Basal Metabolic Rate, Waist-Hip Ratio, Waist Circumference, Visceral Fat Level, Segmental Lean Analysis(Right Arm, Left Arm, Trunk, Right Leg, Left Leg), Segmental Fat Analysis(Right Arm, Left Arm, Trunk, Right Leg, Left Leg), InBody Score, Fat Control, Muscle Control, Impedance (Each segment and each frequency)		
Optional Equipment	Stadiometer from InBody, Blood pressure monitor from InBody, Thermal printer from InBody		
Logo	Name, Address, and Contact Information can be shown on the InBody Results Sheet.		
Digital Results	LCD Monitor, Data management software Lookin'Body		
Types of Result Sheets	InBody Test Results Sheet, InBody Test Results Sheet for Children, InBody Test Thermal Results Sheet		
Voice Guidance	Provides audible indication for test in progress, test complete, and successfully saved settings changes.		
Database	Test results can be saved if the member ID is utilized. The InBody can save up to 100,000 results.		
Test Mode	Self Mode, Professional Mode		
Administrator Menu	Setup: Configure settings and manage data Troubleshooting: Additional information to help use the InBody		
USB Thumb Drive	Copy, backup, or restore the InBody test data (data can be viewed on Excel or Lookin'Body data management software)		
Barcode Reader	The member ID will be automatically inputted when the barcode ID is scanned.		
Backup data	Backup data saved in the InBody by using a USB Thumb Drive, Restore results on the InBody from a backup file.		
Applied Rating Current	200 μ A (\pm 40 μ A)		
Adapter	Bridgepower (BPM040S12F07)	Power Input	AC 100-240V, 50/60Hz, 1.2A(1.2A-0.6A)
		Power Output	DC 12V ---, 3.4A
	Mean Well (GSM40A12-PIIR)	Power Input	AC 100-240V, 50/60Hz, 1.0-0.5A
		Power Output	DC 12V ---, 3.34A
Display Type	480 \times 800 7inch Color TFT LCD		
Internal Interface	Touchscreen, Keypad		
External Interface	RS-232C 4EA, USB HOST 2EA, USB SLAVE 1EA, LAN (10T) 1EA, Bluetooth 1EA, Wi-Fi 1EA		
Compatible Printer	Laser/Inkjet Printers (Printers recommended by InBody) * A list of printers compatible with the InBody can be found at https://www.inbodyservice.com		
Dimension	522 (W) \times 874 (L) \times 1059 (H): mm 20.6 (W) \times 34.4 (L) \times 41.7 (H) : inch		

Equipment Weight	23.8kg (52.4lb)
Testing Time	About 15 seconds
Operation Environment	10 ~ 40°C, 30 ~ 75% RH, 70 ~ 106 kPa
Storage Environment	-10 ~ 70°C, 10 ~ 80% RH, 50 ~ 106 kPa (No Condensation)
Testing Weight Range	10 ~ 250kg (22.0 ~ 551.2lb)
Testing Age Range	3 ~ 99 years
Height Range	95 ~ 220cm (3ft. 1.40in. ~ 7ft. 2.61in.)

* Specifications may change without prior notice.

E. EMC declaration

The InBody370S is intended for use in the electromagnetic environment specified below. The customer or the user of the InBody370S should assure that it is used in such an environment.

Electromagnetic emissions		
Emissions test	Compliance	Electromagnetic environment
RF emissions CISPR 11	Group 1	The InBody370S uses RF energy only for its internal function. Therefore, its RF emissions are very low and are not likely to cause any interference in nearby electronic equipment.
RF emissions CISPR 11	Class A	The InBody370S is suitable for use in all establishments, including domestic establishments and those directly connected to the public low-voltage power supply network that supplies buildings used for domestic purposes.
Harmonic emissions IEC 61000-3-2	Class A	
Voltage fluctuations/ flicker emissions IEC 61000-3-3	Complies	

Electromagnetic immunity – for all ME equipment and ME systems			
Immunity test	IEC 60601 test level	Compliance level	Electromagnetic environment
Electrostatic discharge (ESD) IEC 61000-4-2	± 6 kV contact ± 8 kV air	± 6 kV contact ± 8 kV air	Floors should be wood, concrete or ceramic tile. If floors are covered with synthetic material, the relative humidity should be at least 30 %.
Electrical fast transient/burst IEC 61000-4-4	± 2 kV for power supply lines ± 1 kV for input/output lines	± 2 kV for power supply lines ± 1 kV for input/output lines	Mains power quality should be that of a typical commercial or hospital environment.
Surge IEC 61000-4-5	± 1 kV line(s) to line(s) ± 2 kV line(s) to earth	± 1 kV line(s) to line(s) ± 2 kV line(s) to earth	Mains power quality should be that of a typical commercial or hospital environment.
Voltage dips, short interruptions and voltage variations on power supply input lines IEC 61000-4-11	<5 % UT (>95 % dip in UT) for 0,5 cycle 40 % UT (60 % dip in UT) for 5 cycles 70 % UT (30 % dip in UT) for 25 cycles <5 % UT (>95 % dip in UT) for 5 s	<5 % UT (>95 % dip in UT) for 0,5 cycle 40 % UT (60 % dip in UT) for 5 cycles 70 % UT (30 % dip in UT) for 25 cycles <5 % UT (>95 % dip in UT) for 5 s	Mains power quality should be that of a typical commercial or hospital environment. If the user of the InBody370S requires continued operation during power mains interruptions, it is recommended that the InBody370S be powered from an uninterruptible power supply or a battery.

Power frequency (50/60 Hz) magnetic field IEC 61000-4-8	3 A/m	3 A/m	Power frequency magnetic fields should be at levels characteristic of a typical location in a typical commercial or hospital environment.
---	-------	-------	---

NOTE UT is the a.c. mains voltage prior to application of the test level.

Immunity test	IEC 60601 test level	Compliance level	Electromagnetic environment
Conducted RF IEC 61000-4-6	3 Vrms 150 kHz to 80 MHz	3 Vrms	<p>Portable and mobile RF communications equipment should be used no closer to any part of the InBody370S, including cables, than the recommended separation distance calculated from the equation applicable to the frequency of the transmitter.</p> <p>Recommended separation distance $d=1.2\sqrt{P}$ $d=1.2\sqrt{P}$ 80 MHz to 800 MHz $d=2.3\sqrt{P}$ 800 MHz to 2.5 GHz</p> <p>where P is the maximum output power rating of the transmitter in watts (W) according to the transmitter manufacturer and d is the recommended separation distance in metres (m). Field strengths from fixed RF transmitters, as determined by an electromagnetic site survey,^a should be less than the compliance level in each frequency range.^b</p> <p>Interference may occur in the vicinity of equipment marked with the following symbol:</p> 
Radiated RF IEC 61000-4-3	3 V/m 80 MHz to 2.5 GHz	3 V/m	

NOTE1 At 80 MHz and 800 MHz, the higher frequency range applies.

NOTE2 These guidelines may not apply in all situations. Electromagnetic propagation is affected by absorption and reflection from structures, objects and people.

^a Field strengths from fixed transmitters, such as base stations for radio (cellular/cordless) telephones and land mobile radios, amateur radio, AM and FM radio broadcast and TV broadcast cannot be predicted theoretically with accuracy. To assess the electromagnetic environment due to fixed RF transmitters, an electromagnetic site survey should be considered. If the measured field strength in the location in which the InBody370S is used exceeds the applicable RF compliance level above, the InBody370S should be observed to verify normal operation. If abnormal performance is observed, additional measures may be necessary, such as re-orienting or relocating the InBody370S.

^b Over the frequency range 150 kHz to 80 MHz, field strengths should be less than 3 V/m.

inbody.com

CE 1639

©2020 InBody Co., Ltd. All rights reserved. BM-ENG-I5-G-210111